

Cobra Tools

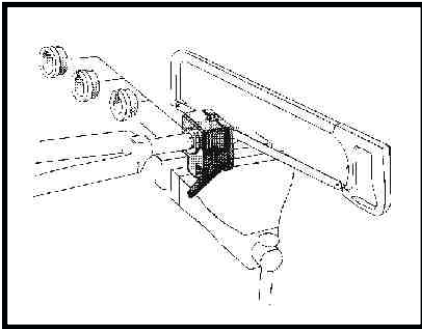

D-185. Threaded and Threadless Fork Saw Guide. 1" - 1 1/8".

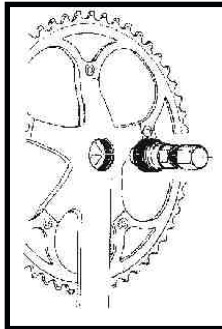

D-002. Cotterless Crank Puller.

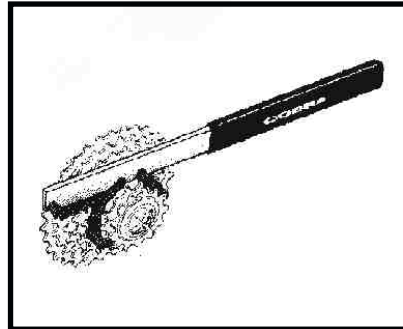

D-009. Chain Sprocket Remover.



D-038, 35 & 36mm. Head Spanner.

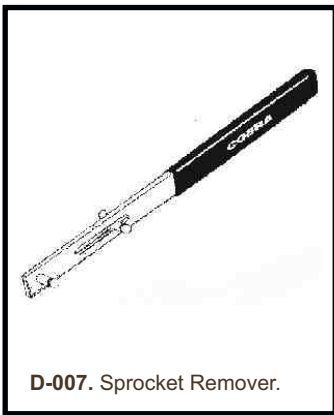

D-007. Sprocket Remover.

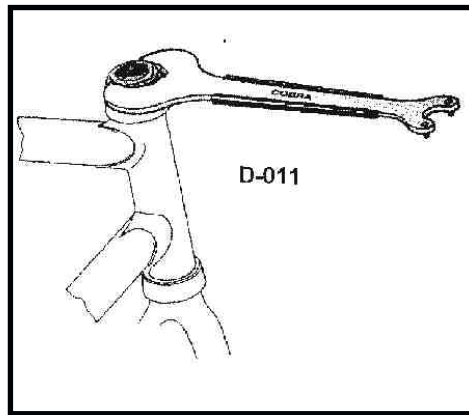

D-011. Headset and Pin Spanner.



D-039. 36 & 40mm. Head Spanner.

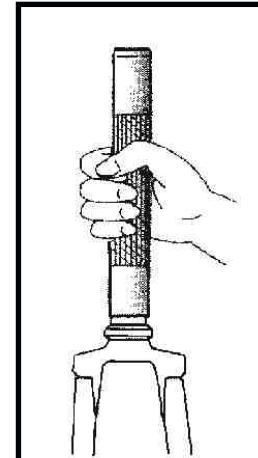

CROWN RACE FITTING TOOL

D-141 For 1" & 1 1/8"

D-014-1-OST-2 For 1 1/4"

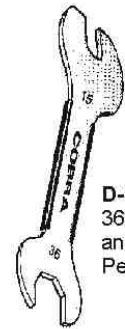

D-040. 36mm. Head and 15mm. Pedal Spanner.

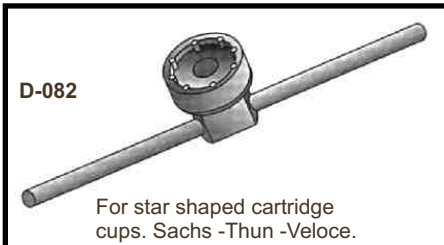

D-082

For star shaped cartridge cups. Sachs -Thun -Veloce.

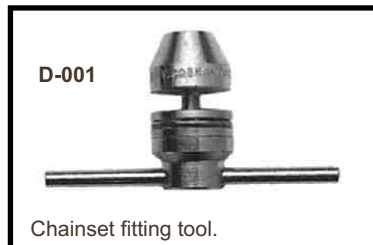

D-001

Chainset fitting tool.



D-108 Threadless nut too for ahead 1" & 1 1/8"

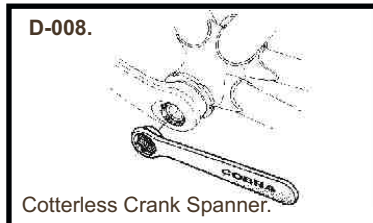

D-008.

Cotterless Crank Spanner.



SPECIAL GREASE with Lithium



I-003 80g.

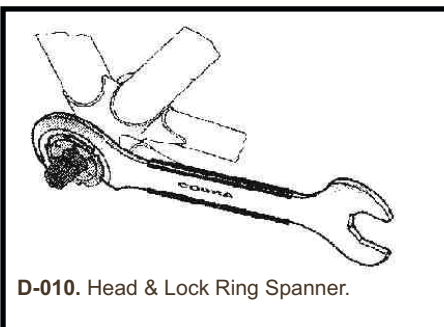

D-010. Head & Lock Ring Spanner.

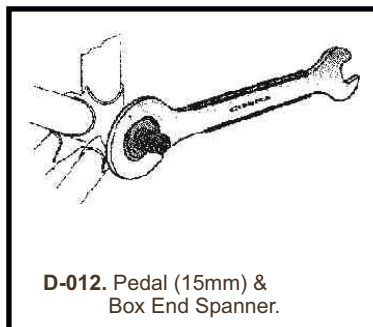

D-012. Pedal (15mm) & Box End Spanner.